



Air-Conditioners For Building Application

2004

TECHNICAL & SERVICE MANUAL

Series PEFY Ceiling Concealed

<Indoor unit>

Models **PEFY-P40VMH-E, PEFY-P50VMH-E**
PEFY-P63VMH-E, PEFY-P71VMH-E
PEFY-P80VMH-E, PEFY-P100VMH-E
PEFY-P125VMH-E, PEFY-P140VMH-E
PEFY-P200VMH-E, PEFY-P250VMH-E

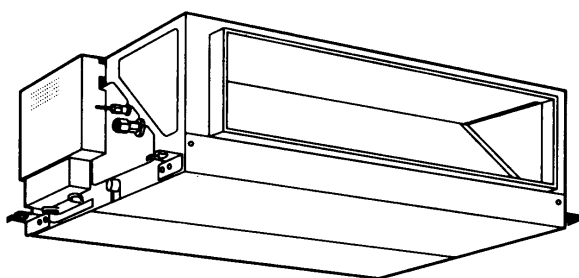

INDOOR UNIT

CONTENTS

SAFETY PRECAUTIONS	1
1. FEATURES	3
2. PART NAMES AND FUNCTIONS	4
3. SPECIFICATION	6
4. OUTLINES AND DIMENSIONS	9
5. WIRING DIAGRAM	11
6. REFRIGERANT SYSTEM DIAGRAM	13
7. TROUBLE SHOOTING	14
8. DISASSEMBLY PROCEDURE	17

CITY MULTI

For use with the R410A & R407C & R22

SAFETY PRECAUTIONS

1. Before installation and electric work

- ▶ **Before installing the unit, make sure you read all the “Safety precautions”.**
- ▶ **The “Safety precautions” provide very important points regarding safety. Make sure you follow them.**
- ▶ **This equipment may cause the adverse effect on the same supply system.**
- ▶ **Please report to or take consent by the supply authority before connection to the system.**

Symbols used in the text

Warning:

Describes precautions that should be observed to prevent danger of injury or death to the user.

Caution:

Describes precautions that should be observed to prevent damage to the unit.

Symbols used in the illustrations



: Indicates an action that must be avoided.



: Indicates that important instructions must be followed.



: Indicates a part which must be grounded.



: Indicates that caution should be taken with rotating parts. (This symbol is displayed on the main unit label.) <Color: Yellow>



: Beware of electric shock (This symbol is displayed on the main unit label.) <Color: Yellow>

Warning:

Carefully read the labels affixed to the main unit.

Warning:

- **Ask the dealer or an authorized technician to install the air conditioner.**
 - Improper installation by the user may result in water leakage, electric shock, or fire.
- **Install the air unit at a place that can withstand its weight.**
 - Inadequate strength may cause the unit to fall down, resulting in injuries.
- **Use the specified cables for wiring. Make the connections securely so that the outside force of the cable is not applied to the terminals.**
 - Inadequate connection and fastening may generate heat and cause a fire.
- **Prepare for typhoons and other strong winds and earthquakes and install the unit at the specified place.**
 - Improper installation may cause the unit to topple and result in injury.
- **Always use an air cleaner, humidifier, electric heater, and other accessories specified by Mitsubishi Electric.**
 - Ask an authorized technician to install the accessories. Improper installation by the user may result in water leakage, electric shock, or fire.

- **Never repair the unit. If the air conditioner must be repaired, consult the dealer.**
 - If the unit is repaired improperly, water leakage, electric shock, or fire may result.
- **Do not touch the heat exchanger fins.**
 - Improper handling may result in injury.
- **If refrigerant gas leaks during installation work, ventilate the room.**
 - If the refrigerant gas comes into contact with a flame, poisonous gases will be released.
- **Install the air conditioner according to this Installation Manual.**
 - If the unit is installed improperly, water leakage, electric shock, or fire may result.
- **Have all electric work done by a licensed electrician according to “Electric Facility Engineering Standard” and “Interior Wire Regulations” and the instructions given in this manual and always use a special circuit.**
 - If the power source capacity is inadequate or electric work is performed improperly, electric shock and fire may result.
- **Keep the electric parts away from water (washing water etc.).**
 - It might result in electric shock, catching fire or smoke.
- **Securely install the cover of control box and the panel.**
 - If the cover and panel are not installed properly, dust or water may enter the outdoor unit and fire or electric shock may result.
- **When installing and moving the air conditioner to another site, do not charge the it with a refrigerant different from the refrigerant specified on the unit.**
 - If a different refrigerant or air is mixed with the original refrigerant, the refrigerant cycle may malfunction and the unit may be damaged.
- **If the air conditioner is installed in a small room, measures must be taken to prevent the refrigerant concentration from exceeding the safety limit even if the refrigerant should leak.**
 - Consult the dealer regarding the appropriate measures to prevent the safety limit from being exceeded. Should the refrigerant leak and cause the safety limit to be exceeded, hazards due to lack of oxygen in the room could result.
- **When moving and reinstalling the air conditioner, consult the dealer or an authorized technician.**
 - If the air conditioner is installed improperly, water leakage, electric shock, or fire may result.
- **After completing installation work, make sure that refrigerant gas is not leaking.**
 - If the refrigerant gas leaks and is exposed to a fan heater, stove, oven, or other heat source, it may generate noxious gases.
- **Do not reconstruct or change the settings of the protection devices.**
 - If the pressure switch, thermal switch, or other protection device is shorted and operated forcibly, or parts other than those specified by Mitsubishi Electric are used, fire or explosion may result.
- **To dispose of this product, consult your dealer.**
- **Do not use a leak detection additive.**

2. Precautions for devices that use R410A or R407C refrigerant

Caution:

- **Do not use the existing refrigerant piping.**
 - The old refrigerant and refrigerator oil in the existing piping contains a large amount of chlorine which may cause the refrigerator oil of the new unit to deteriorate.
- **Use refrigerant piping made of C1220 (Cu-DHP) phosphorus deoxidized copper as specified in the *JIS H3300 "Copper and copper alloy seamless pipes and tubes". In addition, be sure that the inner and outer surfaces of the pipes are clean and free of hazardous sulphur, oxides, dust/dirt, shaving particles, oils, moisture, or any other contaminant.**
 - Contaminants on the inside of the refrigerant piping may cause the refrigerant residual oil to deteriorate.

*JIS: Japanese Industrial Standard
- **Store the piping to be used during installation indoors and keep both ends of the piping sealed until just before brazing. (Store elbows and other joints in a plastic bag.)**
 - If dust, dirt, or water enters the refrigerant cycle, deterioration of the oil and compressor trouble may result.
- **Use ester oil, ether oil or alkylbenzene (small amount) as the refrigerator oil to coat flares and flange connections.**
 - The refrigerator oil will degrade if it is mixed with a large amount of mineral oil.
- **Use liquid refrigerant to fill the system.**
 - If gas refrigerant is used to seal the system, the composition of the refrigerant in the cylinder will change and performance may drop.
- **Do not use a refrigerant other than R410A or R407C.**
 - If another refrigerant (R22, etc.) is used, the chlorine in the refrigerant may cause the refrigerator oil to deteriorate.
- **Use a vacuum pump with a reverse flow check valve..**
 - The vacuum pump oil may flow back into the refrigerant cycle and cause the refrigerator oil to deteriorate.
- **Do not use the following tools that are used with conventional refrigerants.
(Gauge manifold, charge hose, gas leak detector, reverse flow check valve, refrigerant charge base, vacuum gauge, refrigerant recovery equipment)**
 - If the conventional refrigerant and refrigerator oil are mixed in the R410A or R407C, the refrigerant may deteriorate.
 - If water is mixed in the R410A or R407C, the refrigerator oil may deteriorate.
 - Since R410A or R407C does not contain any chlorine, gas leak detectors for conventional refrigerants will not react to it.
- **Do not use a charging cylinder.**
 - Using a charging cylinder may cause the refrigerant to deteriorate.
- **Be especially careful when managing the tools.**
 - If dust, dirt, or water gets in the refrigerant cycle, the refrigerant may deteriorate.

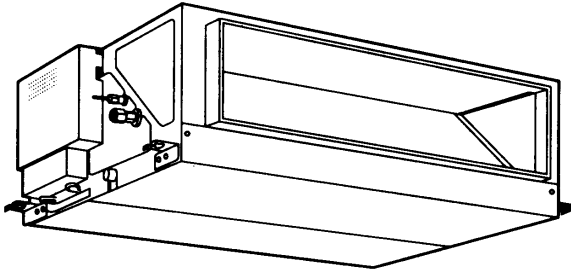
1**FEATURES****Series PEFY Ceiling Concealed**

Indoor unit

Models	Cooling capacity/Heating capacity
	kW
PEFY-P40VMH-E	4.5 / 5.0
PEFY-P50VMH-E	5.6 / 6.3
PEFY-P63VMH-E	7.1 / 8.0
PEFY-P71VMH-E	8.0 / 9.0
PEFY-P80VMH-E	9.0 / 10.0
PEFY-P100VMH-E	11.2 / 12.5
PEFY-P125VMH-E	14.0 / 16.0
PEFY-P140VMH-E	16.0 / 18.0
PEFY-P200VMH-E	22.4 / 25.0
PEFY-P250VMH-E	28.0 / 31.5

2

PART NAMES AND FUNCTIONS

● Indoor (Main) Unit

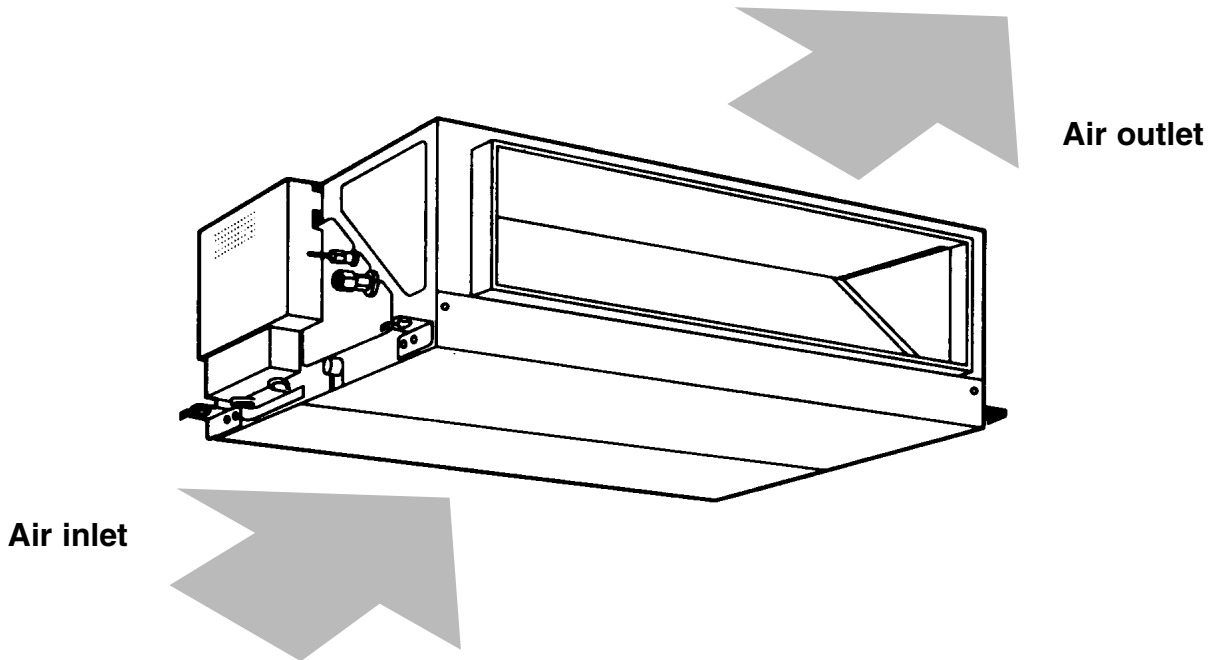

● Remote controller

[PAR-20MAA]

- Once the controls are set, the same operation mode can be repeated by simply pressing the ON/OFF button.

[Operation buttons]

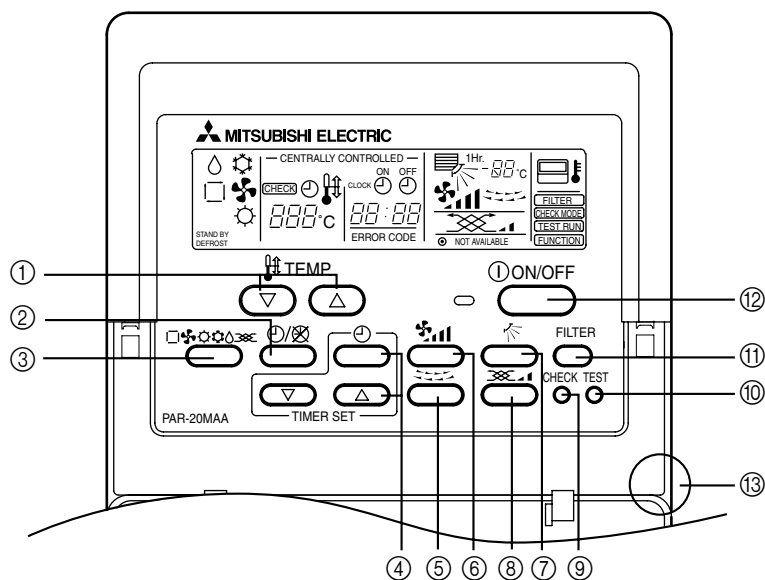

- | | |
|--|---|
| ① [Room temperature adjustment] Button | ⑦ [Up/down airflow direction] Button |
| ② [Timer/continuous] Button | ⑧ [Ventilation] Button |
| ③ [Selecting operation] Button | ⑨ [Checking/built-in] Button |
| ④ [Time selection] Button
[Time-setting] Button | ⑩ [Test run] Button |
| ⑤ [Louver] Button | ⑪ [Filter] Button |
| ⑥ [Fan speed adjustment] Button | ⑫ [ON/OFF] Button |
| | ⑬ Position of built-in room temperature |

- Never expose the remote controller to direct sunlight. Doing so can result in the erroneous measurement of room temperature.
- Never place any obstacle around the lower right-hand section of the remote controller. Doing so can result in the erroneous measurement of room temperature.

[Display]

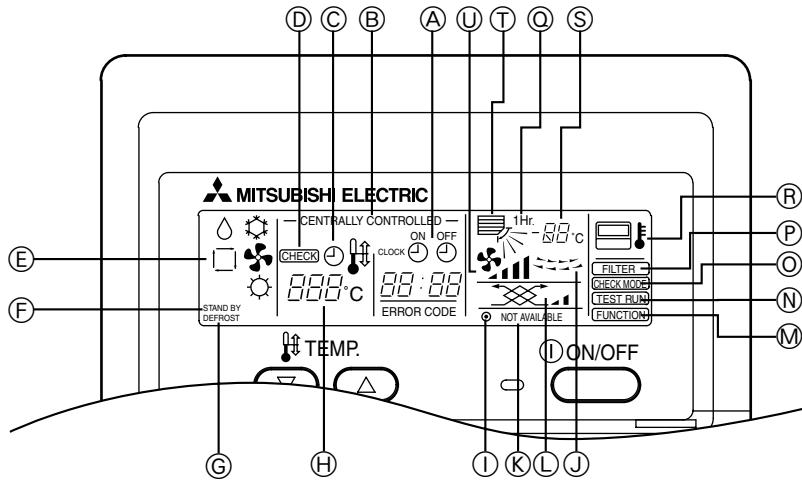

- (A) Current time/Timer
- (B) Centralized control
- (C) Timer ON
- (D) Abnormality occurs
- (E) Operation mode: COOL, DRY, AUTO, FAN, HEAT
- (F) Preparing for Heating mode
- (G) Defrost mode
- (H) Set temperature
- (I) Power ON
- (J) Louver
- (K) Not available function
- (L) Ventilation
- (M) Function setting mode
- (N) Test run mode
- (O) Error check mode
- (P) Filter sign
- (Q) Set effective for 1 hr.
- (R) Sensor position
- (S) Room temperature
- (T) Airflow
- (U) Fan speed

3

SPECIFICATION

3-1. Specification

Model			PEFY-P40VMH-E	PEFY-P50VMH-E	PEFY-P63VMH-E	PEFY-P71VMH-E	
Power source			~ 220-240V 50Hz /60Hz				
Cooling capacity ※ 1		kW	4.5	5.6	7.1	8.0	
Heating capacity ※ 1		kW	5.0	6.3	8.0	9.0	
Power consumption (50/60Hz)	Cooling	kW	0.19/0.23		0.24/0.30	0.26/0.33	
	Heating	kW	0.19/0.23		0.24/0.30	0.26/0.33	
Current	Cooling	A	0.88/1.06		1.12/1.38	1.20/1.51	
	Heating	A	0.88/1.06		1.12/1.38	1.20/1.51	
External finish			Galvanizing				
Dimension	Height	mm	380				
	Width	mm	750			1000	
	Depth	mm	900				
Net weight		kg	44	45		50	
Heat exchanger			Cross fin (Aluminum plate fin and copper tube)				
Fan	Type		Sirocco fanX 1				
	Airflow rate (Lo-Hi)		m ³ /min	10.0-14.0		13.5-19.0	15.5-22.0
	External static pressure ※ 2	220V	Pa	50/100/200			
		230, 240V	Pa	100/150/200			
Motor	Type		Single phase induction motor				
	Output ※ 3		kW	0.08	0.12	0.14	
Air filter (option)			Synthetic fiber unwoven cloth filter(long life)				
Refrigerant pipe dimension	Gas (Flare)	mm	ø 12.7	ø 12.7(R410A) ø 15.88(R22,R407C)	ø 15.88		
	Liquid (Flare)	mm	ø 6.35	ø 6.35(R410A) ø 9.52(R22,R407C)	ø 9.52		
Drain pipe dimension			32 (1-1/4 inch)				
Noise level (Lo-Hi)	220V	dB(A)	27-34		32-38	32-39	
	230, 240V	dB(A)	31-37		36-41	35-41	

Note: ※ 1 Cooling/Heating capacity indicates the maximum value at operation under the following condition.
Cooling : Indoor 27°CDB/19°CWB, Outdoor 35°CDB (WR2: water 30°C)
Heating : Indoor 20°CDB, Outdoor 7°CDB/6°CWB (WR2: water 20°C)

※ 2 The external static pressure is set to 100Pa (at 220V) /150Pa (at 230, 240V) at factory shipment.

※ 3 The value are that at 240V.

Model			PEFY-P80VMH-E	PEFY-P100VMH-E	PEFY-P125VMH-E	PEFY-P140VMH-E
Power source			~ 220-240V 50Hz /60Hz			
Cooling capacity ※ 1		kW	9.0	11.2	14.0	16.0
Heating capacity ※ 1		kW	10.0	12.5	16.0	18.0
Power consumption (50/60Hz)	Cooling	kW	0.32/0.40		0.48/0.58	
	Heating	kW	0.32/0.40		0.48/0.58	
Current	Cooling	A	1.47/1.83		2.34/2.66	
	Heating	A	1.47/1.83		2.34/2.66	
External finish			Galvanizing			
Dimension	Height	mm	380			
	Width	mm	1000	1200		
	Depth	mm	900			
Net weight		kg	50	70		
Heat exchanger			Cross fin (Aluminum plate fin and copper tube)			
Fan	Type		Sirocco fan× 1		Sirocco fan× 2	
	Airflow rate (Lo-Hi)		m ³ /min		26.5-38.0	
	External static pressure ※2	220V	Pa	50/100/200		
230, 240V		Pa	100/150/200			
Motor	Type		Single phase induction motor			
	Output ※ 3		kW		0.26	
Air filter (option)			Synthetic fiber unwoven cloth filter(long life)			
Refrigerant pipe dimension	Gas (Flare)	mm	ø 15.88	ø 15.88 (R410A) ø 19.05 (R22,R407C)		
	Liquid (Flare)	mm	ø 9.52			
Drain pipe dimension			32 (1-1/4 inch)			
Noise level (Lo-Hi)	220V	dB(A)	35-41		34-42	
	230, 240V	dB(A)	38-43		38-44	

Model			PEFY-P200VMH-E	PEFY-P250VMH-E
Power source			3N ~ 380-415V 50Hz / 60Hz	
Cooling capacity ※ 1		kW	22.4	28.0
Heating capacity ※ 1		kW	25.0	31.5
Power consumption (50/60Hz)	Cooling	kW	0.99/1.14	
	Heating	kW	0.99/1.14	
Current	Cooling	A	1.62/1.86	
	Heating	A	1.62/1.86	
External finish			Galvanizing	
Dimension	Height	mm	470	
	Width	mm	1250	
	Depth	mm	1120	
Net weight		kg	100	
Heat exchanger			Cross fin (Aluminum plate fin and copper tube)	
Fan	Type		Sirocco fan× 2	
	Airflow rate		m ³ /min	
	External static pressure ※ 4	380V	Pa	110/220
400, 415V		Pa	130/260	
Motor	Type		phase induction motor	
	Output ※5		kW	
Air filter (option)			Synthetic fiber unwoven cloth filter(long life)	
Refrigerant pipe dimension	Gas (Brazing)	mm	ø 19.05 (R410A) ø 25.4 (R22,R407C)	
	Liquid (Brazing)	mm	ø 9.52 (R410A) ø 12.7 (R22,R407C)	
Drain pipe dimension			32 (1-1/4 inch)	
Noise level	380V	dB(A)	42(110Pa)/45(220Pa)	
	400, 415V	dB(A)	44(130Pa)/47(260Pa)	

Note: ※ 1 Cooling/Heating capacity indicates the maximum value at operation under the following condition.
Cooling : Indoor 27°CDB/19°CWB, Outdoor 35°CDB (WR2: water 30°C)
Heating : Indoor 20°CDB, Outdoor 7°CDB/6°CWB (WR2: water 20°C)
※ 2 The external static pressure is set to 100Pa (at 220V) /150Pa (at 230, 240V) at factory shipment.
※ 3 The value are that at 240V.
※ 4 The external static pressure is set to 110Pa (at 380V) /130Pa (at 400, 415V) at factory shipment.
※ 5 The value are that at 415V.

3-2. Electrical parts specifications

Model Parts name	Symbol	PEFY- P40VMH-E	PEFY- P50VMH-E	PEFY- P63VMH-E	PEFY- P71VMH-E	PEFY- P80VMH-E	PEFY- P100VMH-E	PEFY- P125VMH-E	PEFY- P140VMH-E	PEFY- P200VMH-E	PEFY- P250VMH-E
Transformer	T	(Primary) 50/60Hz 220-240V (Secondary) (23.5V 0.9A)									
Room temperature thermistor	TH21	Resistance 0°C/15kΩ,10°C/9.6kΩ,20°C/6.3kΩ,25°C/5.4kΩ,30°C/4.3kΩ,40°C/3.0kΩ									
Liquid pipe thermistor	TH22	Resistance 0°C/15kΩ,10°C/9.6kΩ,20°C/6.3kΩ,25°C/5.4kΩ,30°C/4.3kΩ,40°C/3.0kΩ									
Gas pipe thermistor	TH23	Resistance 0°C/15kΩ,10°C/9.6kΩ,20°C/6.3kΩ,25°C/5.4kΩ,30°C/4.3kΩ,40°C/3.0kΩ									
Fuse (Indoor controller board)	FUSE	250V 6.3A									
Fan motor (with Inner-thermostat)	MF1,2	4-pole OUTPUT 130W NC-45VMH	4-pole Output 180W NC-71VMH	4-pole Output 220W NC-80VMH	4-pole Output 230W NC-90VMH	4-pole OUTPUT 400W NS-112VMH			4-pole Output 550W NS-200VMH	4-pole Output 800W NS-250VMH	
Inner-thermostat (Fan motor)		OFF 135°C±5°C ON 95°C±20°C									
Fan motor capacitor	C1	3.0μF×440V	4.0μF ×440V	5.0μF×440V		7.0μF×440V			-		
Linear expansion valve	LEV	DC12V Stepping motor drive port dimension ø 3.2 (0~1800pulse <at R410A outdoor unit> 0~2000pulse <at the other outdoor unit>)			DC12V Stepping motor drive port dimension ø 5.2 (0~1800pulse <at R410A outdoor unit> 0~2000pulse <at the other outdoor unit>)			DC12V Stepping motor drive port dimension ø 6.4 (0~1800pulse <at R410A outdoor unit> 0~2000pulse <at the other outdoor unit>)	DC12V Stepping motor drive port dimension ø 5.2 (0~1800pulse <at R410A outdoor unit> 0~2000pulse <at the other outdoor unit>)		
Power supply terminal bed	TB2	(L,N,⊕) 330V 30A								(L1,L2,L3,N,⊕) 660V 40A	
Transmission terminal bed	TB5 TB15	(1,2),(M1,M2,S) 300V 10A									

PEFY-P200-250VMH-E

Unit : mm

Required space for service and maintenance

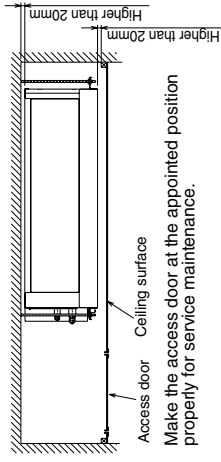
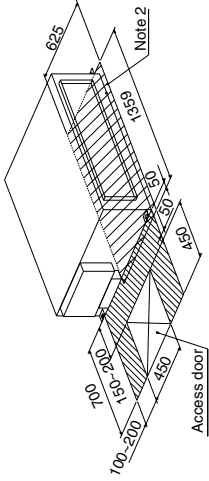

Make the access door at the appointed position properly for service maintenance.

- Note 1. Use M10 screw for the lifting bolt (field supply).
 - 2. Keep the service space for the maintenance from the bottom when the heat exchanger is cleaned.
 - 3. Make sure to install the air filter (field supply) on the air intake side.
- In case field supplied air filter is used, attach it where the filter service is easily done.

Model	A		B	
	※1	※2	※1	※2
P200VMH-E	φ19.05	φ25.4	φ9.52	φ12.7
P250VMH-E	φ22.2	φ28.58	φ9.52	φ12.7

※1: R410A outdoor unit
※2: The other outdoor unit

- ① Refrigerant piping flare connection (gas M copper tube); HP.....
- ② Refrigerant piping flare connection (liquid N copper tube); LP.....
- ③ Drain hose 32mm (1-1/4inch) <flexible joint 200mm> (accessory).....

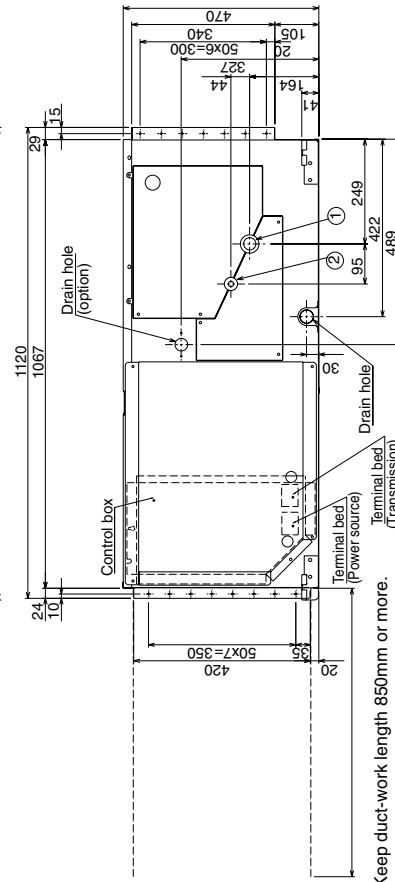
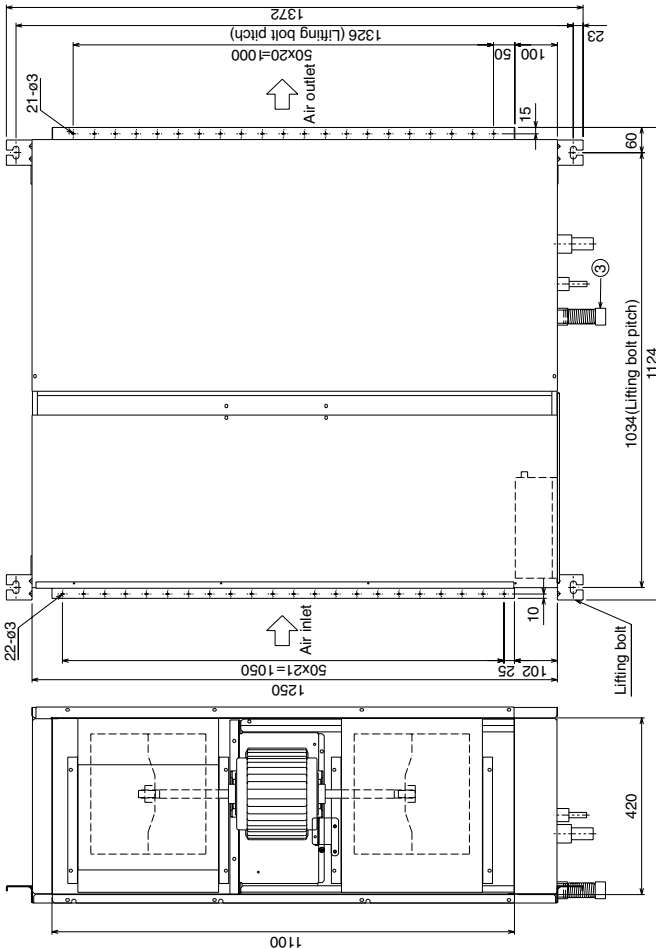
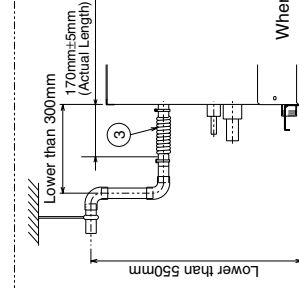
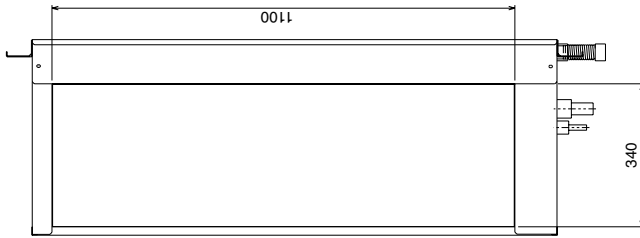

When installing the drain water lifting-up mech (option).

Keep duct-work length 850mm or more.

PEFY-P40-50-63-71-80-100-125-140VMH-E

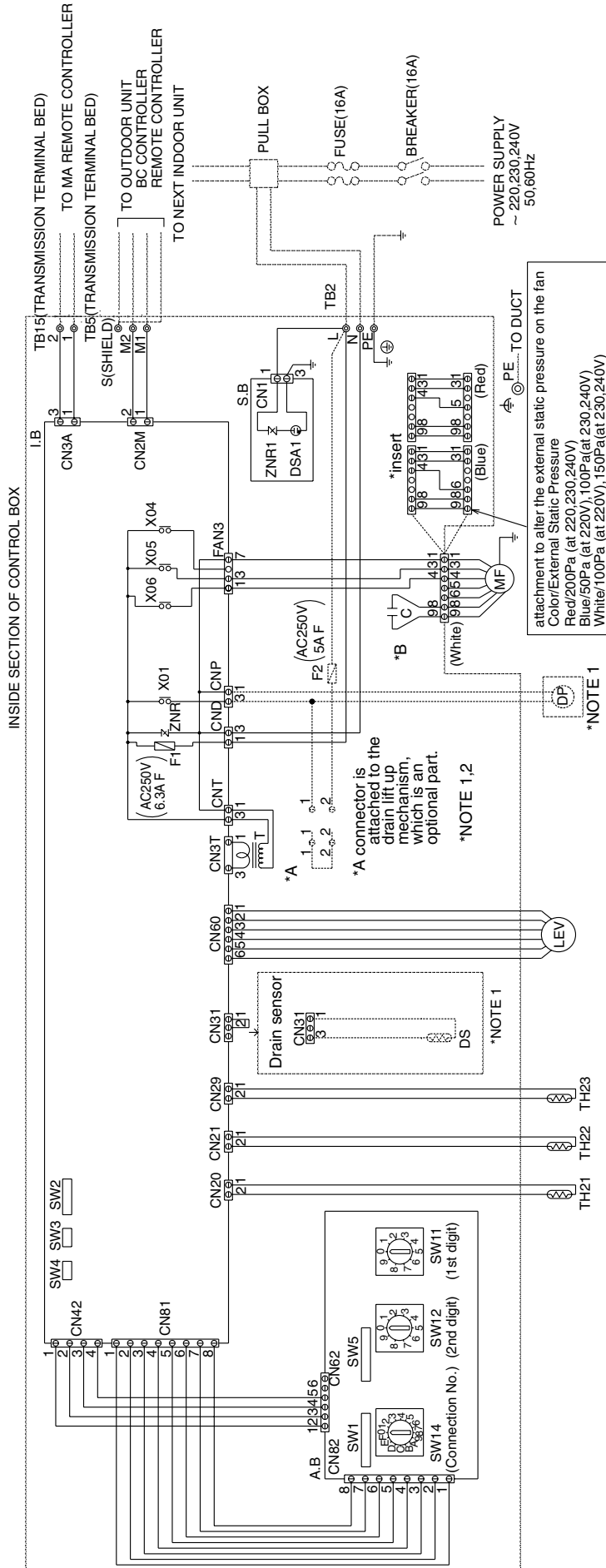

SYMBOL EXPLANATION

SYMBOL	NAME	SYMBOL	NAME
MF	Fan motor	S, B	Surge absorber board
C	*B Capacitor (for MF)	TH21	Thermistor (inlet temp. detection)
I, B	Indoor controller board	TH22	Thermistor (piping temp. detection/liquid)
A, B	Address board	TH23	Thermistor (piping temp. detection/gas)
TB2	Power source terminal bed	SW11(A, B)	Switch (1st digit address set)
TB5	Transmission terminal bed	SW12(A, B)	Switch (2nd digit address set)
TB15	Transmission terminal bed	SW14(A, B)	Switch (connection No. set)
F1	Fuse AC250V 6.3A F	SW1(A, B)	Switch (for mode selection)
<F2>	Fuse AC250V 5A F	SW2(I, B)	Switch (for capacity code)
T	Transformer	SW3(I, B)	Switch (for mode selection)
<DP>	Drain Pump	SW4(I, B)	Switch (for model selection)
LEV	Electronic linear expans. valve	SW5(A, B)	Switch (for voltage selection)
<DS>	Drain sensor	X04-X06	Aux. relay

inside < > is the optional parts.

NOTE: 1. The part of the broken line indicates the circuit for optional parts.

2. *A in the chart is the connector for a drain pump test run operation. (The Drain Pump operates continuously if the connector is inserted and the power is supplied.) After the test run, make sure to remove the *A connector.

3. The wirings to TB2, TB5 (shown in dotted line) are field work.

4. Mark ⊕ indicates terminal bed, ⊖ connector, ⊕ board insertion connector or fastening connector of control board.

*B Capacitor
 MODELS 40/50 3.0μF
 MODEL 63 4.0μF
 MODELS 71/80 5.0μF
 MODELS 100/125/140 7.0μF

*A connector is attached to the drain lift up mechanism, which is an optional part.
 *NOTE 1, 2

*insert
 attachment to alter the external static pressure on the fan
 Color/External Static Pressure
 Red/200Pa (at 220V, 230, 240V)
 Blue/50Pa (at 220V), 100Pa (at 230, 240V)
 White/100Pa (at 220V), 150Pa (at 230, 240V)

PEFY-P200·250VMH-E

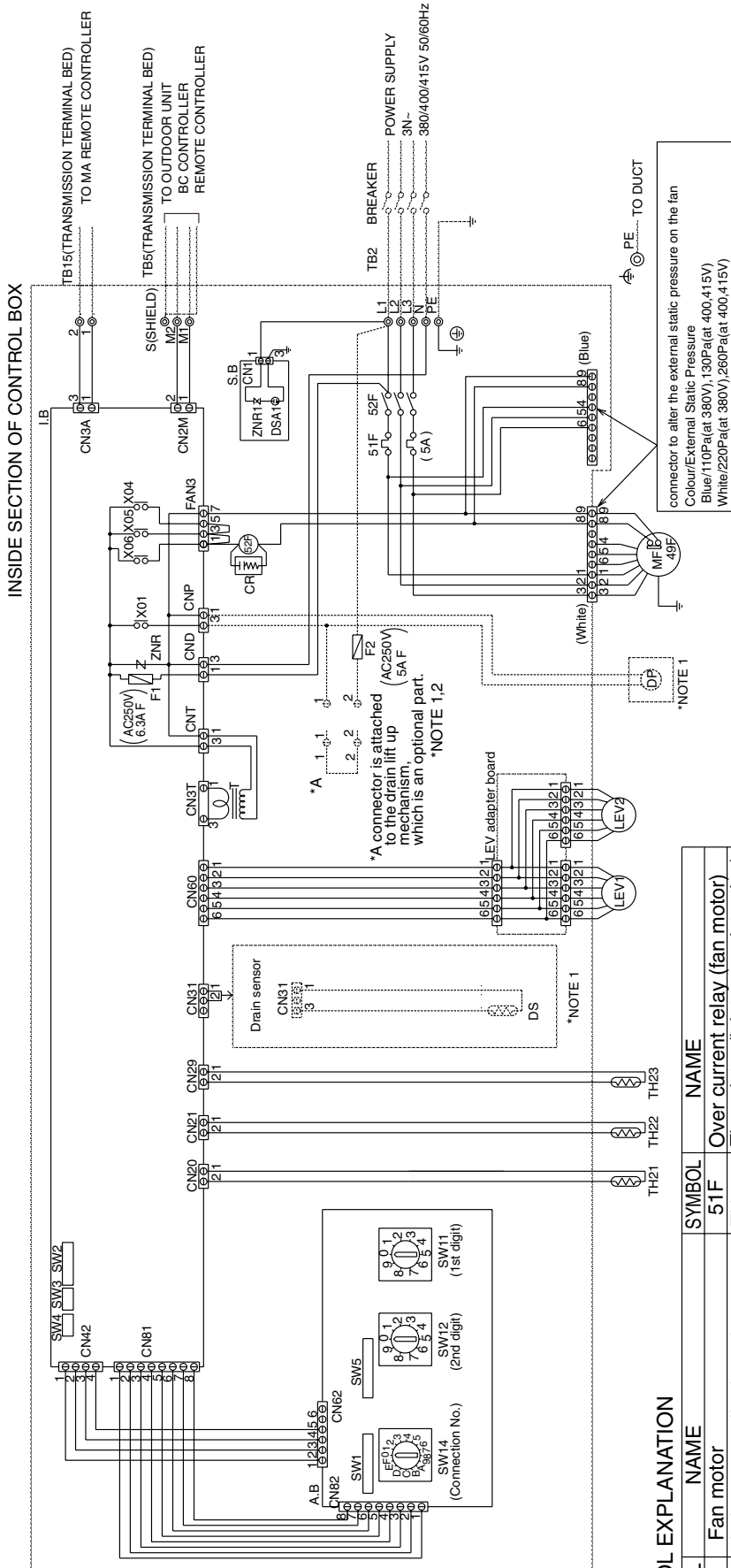

SYMBOL EXPLANATION

SYMBOL	NAME	SYMBOL	NAME
MF	Fan motor	51F	Over current relay (fan motor)
I.B	Indoor controller board	TH21	Thermistor (inlet temp. detection)
A.B	Address board	TH22	Thermistor (piping temp. detection/liquid)
TB2	Power source terminal bed	TH23	Thermistor (piping temp. detection/gas)
TB5	Transmission terminal bed	SW1(A,B)	Switch (1st digit address set)
TB15	Transmission terminal bed	SW12(A,B)	Switch (2nd digit address set)
F1	Fuse AC250V 6.3A F	SW14(A,B)	Switch (connection No. set)
<F2>	Fuse AC250V 5A F	SW1(A,B)	Switch(for mode selection)
T	Transformer	SW2(L,B)	Switch(for capacity code)
<DP>	Drain Pump	SW3(L,B)	Switch(for mode selection)
LEV1,LEV2	Electronic linear expan. valve	SW4(L,B)	Switch(for model selection)
<DS>	Drain sensor	SW5(A,B)	Switch(for voltage selection)
S.B	Surge absorber board	X04-X06	Aux. relay
52F	Contacting (fan motor)	49F	Inner thermostat

inside < > is the optional parts.

CAUTION; 1. To protect Fan motor from abnormal current, Over current relays <51F> is installed. Therefore, do not change factory set value of Over current relays.

- NOTE;** 1. The part of the broken line indicates the circuit for optional parts.
 2. *A in the chart is the connector for a drain pump test run operation. (The Drain Pump operates continuously if the connector is inserted and the power is supplied.)
 After the test run, make sure to remove the *A connector.
 3. The wirings to TB2, TB5 shown in dotted line are field work.
 4. Mark ⊙ indicates terminal bed, ⊖ connector, ⊞ board insertion connector or fastening connector of control board.

6

REFRIGERANT SYSTEM DIAGRAM

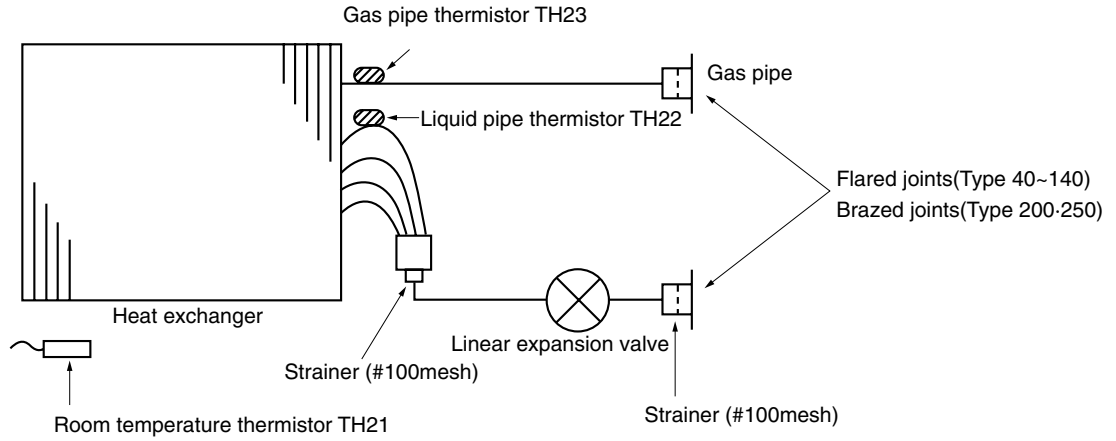

Item \ Capacity	PEFY-P40VMH-E	PEFY-P50VMH-E	PEFY-P63,71,80VMH-E
Gas pipe	ø 12.7 <1/2F>	ø 12.7 <1/2F> (R410A) ø 15.88 <5/8F> (R22,R407C)	ø 15.88 <5/8F>
Liquid pipe	ø 6.35 <1/4F>	ø 6.35 <1/4F> (R410A) ø 9.52 <3/8F> (R22,R407C)	ø 9.52 <3/8F>

Item \ Capacity	PEFY-P100,125,140VMH-E	PEFY-P200VMH-E	PEFY-P250VMH-E
Gas pipe	ø 15.88 <5/8F> (R410A) ø 19.05 <3/4F> (R22,R407C)	ø 19.05 <3/4> (R410A) ø 25.4 <1> (R22,R407C)	ø 22.2 <7/8> (R410A) ø 28.58 <1-1/8> (R22,R407C)
Liquid pipe	ø 9.52 <3/8F>	ø 9.52 <3/8> (R410A) ø 12.7 <1/2> (R22,R407C)	ø 9.52 <3/8> (R410A) ø 12.7 <1/2> (R22,R407C)

7

TROUBLE SHOOTING

7-1. How to check the parts

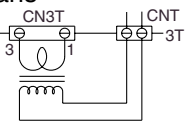
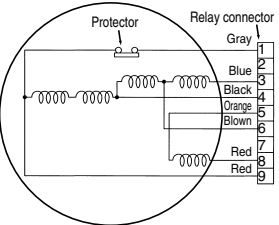
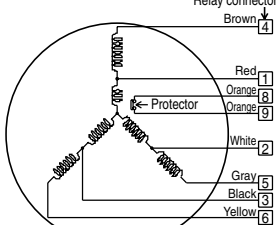
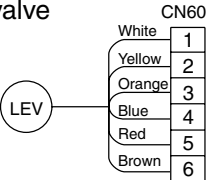
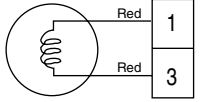
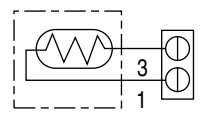
Parts name	Check points																																												
Room temperature thermistor (TH21) Liquid pipe thermistor (TH22) Gas pipe thermistor (TH23)	Disconnect the connector, then measure the resistance using a tester. (Surrounding temperature 10°C~30°C)																																												
	<table border="1"> <tr> <th>Normal</th> <th>Abnormal</th> </tr> <tr> <td>4.3kΩ~9.6kΩ</td> <td>Open or short</td> </tr> </table>	Normal	Abnormal	4.3kΩ~9.6kΩ	Open or short	(Refer to the thermistor characteristic graph)																																							
Normal	Abnormal																																												
4.3kΩ~9.6kΩ	Open or short																																												
Trans 	Disconnect the connector and measure the resistance using a tester.																																												
	<table border="1"> <tr> <th></th> <th>Normal</th> <th>Abnormal</th> </tr> <tr> <td>CNT(1)-(3)</td> <td>App.15Ω</td> <td rowspan="2">Open or short</td> </tr> <tr> <td>CN3T(1)-(3)</td> <td>App.4Ω</td> </tr> </table>		Normal	Abnormal	CNT(1)-(3)	App.15Ω	Open or short	CN3T(1)-(3)	App.4Ω																																				
	Normal	Abnormal																																											
CNT(1)-(3)	App.15Ω	Open or short																																											
CN3T(1)-(3)	App.4Ω																																												
Fan motor PEFY-P40~140 	Measure the resistance between the terminals using a tester. (at 20°C)																																												
	<table border="1"> <thead> <tr> <th rowspan="2">Motor terminal or Relay connector</th> <th colspan="5">Normal</th> <th rowspan="2">Abnormal</th> </tr> <tr> <th>P40-50</th> <th>P63</th> <th>P71</th> <th>P80</th> <th>P100-125-140</th> </tr> </thead> <tbody> <tr> <td>Gray-Orange</td> <td>68.8Ω</td> <td>47Ω</td> <td>32.9Ω</td> <td>33.3Ω</td> <td>14.05Ω</td> <td rowspan="5">Open or short</td> </tr> <tr> <td>Gray-Black</td> <td>53.73Ω</td> <td>37.29Ω</td> <td>27.56Ω</td> <td>27.1Ω</td> <td>9.11Ω</td> </tr> <tr> <td>Gray-Brown</td> <td>59.92Ω</td> <td>39.81Ω</td> <td>30.64Ω</td> <td>28.56Ω</td> <td>9.87Ω</td> </tr> <tr> <td>Gray-Blue</td> <td>74.17Ω</td> <td>49.8Ω</td> <td>38.31Ω</td> <td>36.82Ω</td> <td>12.89Ω</td> </tr> <tr> <td></td> <td></td> <td></td> <td></td> <td></td> <td></td> </tr> </tbody> </table>	Motor terminal or Relay connector	Normal					Abnormal	P40-50	P63	P71	P80	P100-125-140	Gray-Orange	68.8Ω	47Ω	32.9Ω	33.3Ω	14.05Ω	Open or short	Gray-Black	53.73Ω	37.29Ω	27.56Ω	27.1Ω	9.11Ω	Gray-Brown	59.92Ω	39.81Ω	30.64Ω	28.56Ω	9.87Ω	Gray-Blue	74.17Ω	49.8Ω	38.31Ω	36.82Ω	12.89Ω							
Motor terminal or Relay connector	Normal					Abnormal																																							
	P40-50	P63	P71	P80	P100-125-140																																								
Gray-Orange	68.8Ω	47Ω	32.9Ω	33.3Ω	14.05Ω	Open or short																																							
Gray-Black	53.73Ω	37.29Ω	27.56Ω	27.1Ω	9.11Ω																																								
Gray-Brown	59.92Ω	39.81Ω	30.64Ω	28.56Ω	9.87Ω																																								
Gray-Blue	74.17Ω	49.8Ω	38.31Ω	36.82Ω	12.89Ω																																								
Fan motor PEFY-P200-250 	Measure the resistance between the terminals using a tester. (at 20°C)																																												
	<table border="1"> <thead> <tr> <th>Motor terminal or Relay connector</th> <th>Normal</th> <th>Abnormal</th> </tr> </thead> <tbody> <tr> <td>Red-White</td> <td>5Ω</td> <td rowspan="7">Open or short</td> </tr> <tr> <td>White-Black</td> <td>5Ω</td> </tr> <tr> <td>Red-Black</td> <td>5Ω</td> </tr> <tr> <td>Brown-Gray</td> <td>6.08Ω</td> </tr> <tr> <td>Gray-Yellow</td> <td>6.08Ω</td> </tr> <tr> <td>Brown-Yellow</td> <td>6.08Ω</td> </tr> <tr> <td></td> <td></td> </tr> </tbody> </table>	Motor terminal or Relay connector	Normal	Abnormal	Red-White	5Ω	Open or short	White-Black	5Ω	Red-Black	5Ω	Brown-Gray	6.08Ω	Gray-Yellow	6.08Ω	Brown-Yellow	6.08Ω																												
Motor terminal or Relay connector	Normal	Abnormal																																											
Red-White	5Ω	Open or short																																											
White-Black	5Ω																																												
Red-Black	5Ω																																												
Brown-Gray	6.08Ω																																												
Gray-Yellow	6.08Ω																																												
Brown-Yellow	6.08Ω																																												
Linear expansion valve 	Disconnect the connector then measure the resistance valve using a tester.																																												
	<table border="1"> <thead> <tr> <th colspan="4">Normal</th> <th>Abnormal</th> </tr> </thead> <tbody> <tr> <td>(1)-(5) White-Red</td> <td>(2)-(6) Yellow-Brown</td> <td>(3)-(5) Orange-Red</td> <td>(4)-(6) Blue-Brown</td> <td rowspan="2">Open or short</td> </tr> <tr> <td colspan="4">150Ω ±10%</td> </tr> </tbody> </table>	Normal				Abnormal	(1)-(5) White-Red	(2)-(6) Yellow-Brown	(3)-(5) Orange-Red	(4)-(6) Blue-Brown	Open or short	150Ω ±10%																																	
Normal				Abnormal																																									
(1)-(5) White-Red	(2)-(6) Yellow-Brown	(3)-(5) Orange-Red	(4)-(6) Blue-Brown	Open or short																																									
150Ω ±10%																																													
Drain Pump (Drain water lift up kit) 	Disconnect the connector then measure the resistance valve using a tester. (Surrounding temperature 20°C~30°C)	<Thermistor characteristic graph> Room temperature thermistor(TH21) Liquid pipe thermistor(TH22) Gas pipe temperature thermistor(TH23) Drain sensor(DS) Thermistor R0=15kΩ ± 3% Fixed number of B=3480kΩ ± 2% $R_t = 15 \exp \left\{ 3480 \left(\frac{1}{273+t} - \frac{1}{273} \right) \right\}$ 0°C 15kΩ 10°C 9.6kΩ 20°C 6.3kΩ 25°C 5.2kΩ 30°C 4.3kΩ 40°C 3.0kΩ																																											
	<table border="1"> <tr> <th>Normal</th> <th>Abnormal</th> </tr> <tr> <td>399Ω</td> <td>Open or short</td> </tr> </table>		Normal	Abnormal	399Ω	Open or short																																							
Normal	Abnormal																																												
399Ω	Open or short																																												
Drain sensor (Drain water lift up kit) 	Measure the resistance between the terminals using a tester. (Refer to the thermistor characteristic graph)	<table border="1"> <tr> <td>0°C/6.0kΩ, 10°C/3.9kΩ</td> </tr> <tr> <td>20°C/2.6kΩ, 25°C/2.2kΩ</td> </tr> <tr> <td>30°C/1.8kΩ, 40°C/1.3kΩ</td> </tr> </table>	0°C/6.0kΩ, 10°C/3.9kΩ	20°C/2.6kΩ, 25°C/2.2kΩ	30°C/1.8kΩ, 40°C/1.3kΩ																																								
0°C/6.0kΩ, 10°C/3.9kΩ																																													
20°C/2.6kΩ, 25°C/2.2kΩ																																													
30°C/1.8kΩ, 40°C/1.3kΩ																																													

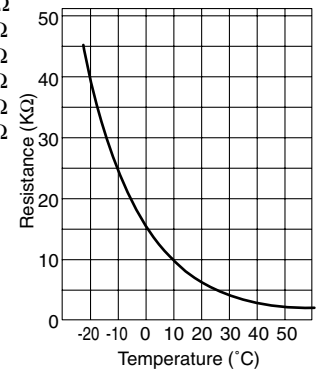

7-2. Setting of address switch

Make sure that power source is turning off.

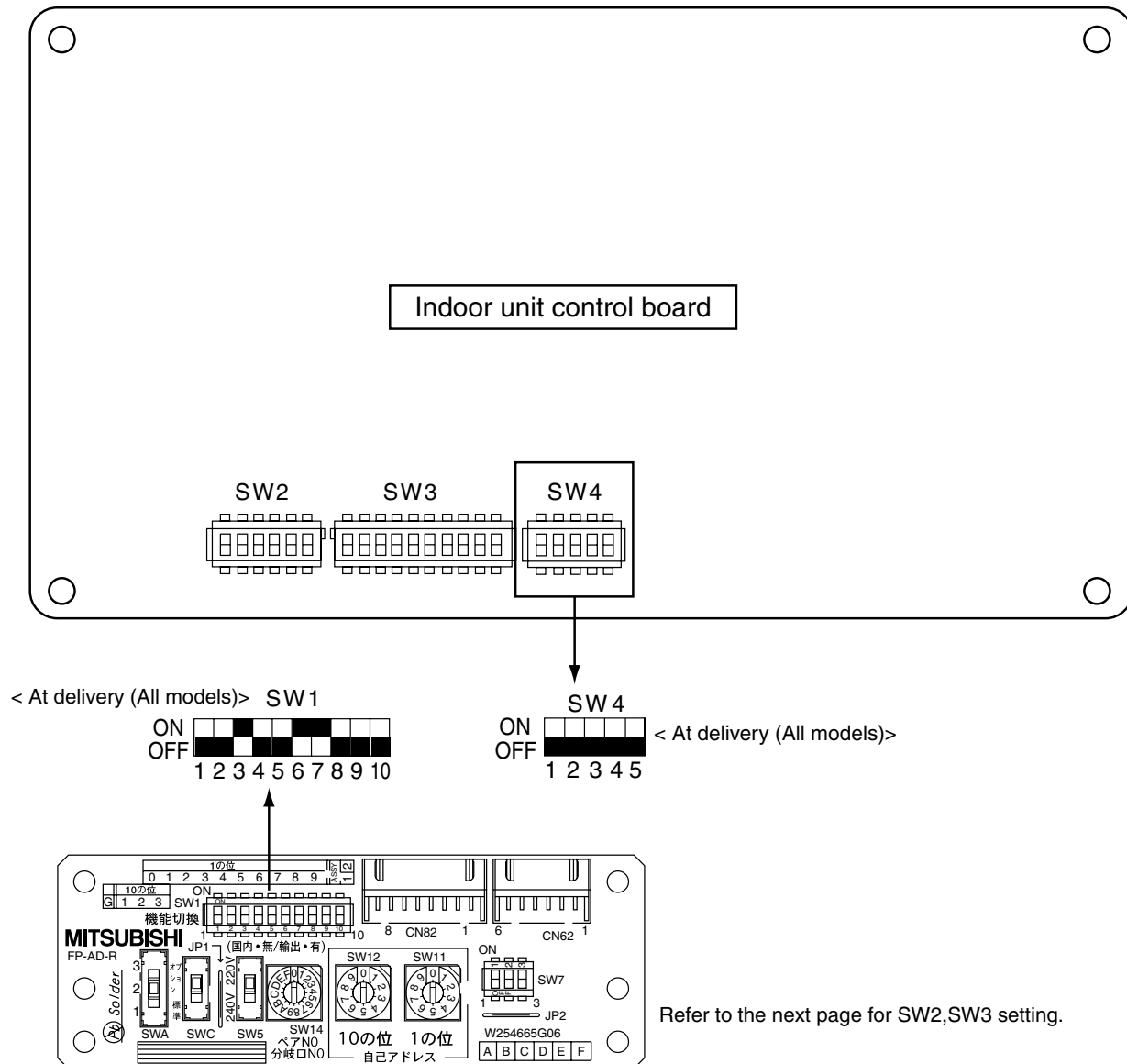

1) In case using network remote controller, address is set by rotary switches.(SW11,SW12)

* It is not necessary setting address in case of using unit remote controller.

Indoor unit do not run without address setting in field.

2) Indoor unit address setting rule is different by each field work.

Refer to install manual of outdoor unit , operate the address setting.

3) Setting the address is combination of SW11(1st digit address setting) and SW12(2nd digit address setting).

Address " 3 " setting is composed SW11 " 3 " and SW12 " 0 " .

Address " 25 " setting is composed SW11 " 5 " and SW12 " 2 " .

7-3. Setting of Dip-switch (at delivery)

Models	Dip-SW					SWA 1	SWC Standard Indicate “標準”
PEFY-P40VMH-E	SW1 ON OFF 1 2 3 4 5 6 7 8 9 10	SW2 ON OFF 1 2 3 4 5 6	SW3 ON OFF 1 2 3 4 5 6 7 8 9 10	SW4 ON OFF 1 2 3 4 5	SW5 ON OFF 220V 240V		
PEFY-P50VMH-E	SW1 ON OFF 1 2 3 4 5 6 7 8 9 10	SW2 ON OFF 1 2 3 4 5 6	SW3 ON OFF 1 2 3 4 5 6 7 8 9 10	SW4 ON OFF 1 2 3 4 5	SW5 ON OFF 220V 240V		
PEFY-P63VMH-E	SW1 ON OFF 1 2 3 4 5 6 7 8 9 10	SW2 ON OFF 1 2 3 4 5 6	SW3 ON OFF 1 2 3 4 5 6 7 8 9 10	SW4 ON OFF 1 2 3 4 5	SW5 ON OFF 220V 240V		
PEFY-P71VMH-E	SW1 ON OFF 1 2 3 4 5 6 7 8 9 10	SW2 ON OFF 1 2 3 4 5 6	SW3 ON OFF 1 2 3 4 5 6 7 8 9 10	SW4 ON OFF 1 2 3 4 5	SW5 ON OFF 220V 240V		
PEFY-P80VMH-E	SW1 ON OFF 1 2 3 4 5 6 7 8 9 10	SW2 ON OFF 1 2 3 4 5 6	SW3 ON OFF 1 2 3 4 5 6 7 8 9 10	SW4 ON OFF 1 2 3 4 5	SW5 ON OFF 220V 240V		
PEFY-P100VMH-E	SW1 ON OFF 1 2 3 4 5 6 7 8 9 10	SW2 ON OFF 1 2 3 4 5 6	SW3 ON OFF 1 2 3 4 5 6 7 8 9 10	SW4 ON OFF 1 2 3 4 5	SW5 ON OFF 220V 240V		
PEFY-P125VMH-E	SW1 ON OFF 1 2 3 4 5 6 7 8 9 10	SW2 ON OFF 1 2 3 4 5 6	SW3 ON OFF 1 2 3 4 5 6 7 8 9 10	SW4 ON OFF 1 2 3 4 5	SW5 ON OFF 220V 240V		
PEFY-P140VMH-E	SW1 ON OFF 1 2 3 4 5 6 7 8 9 10	SW2 ON OFF 1 2 3 4 5 6	SW3 ON OFF 1 2 3 4 5 6 7 8 9 10	SW4 ON OFF 1 2 3 4 5	SW5 ON OFF 220V 240V		
PEFY-P200VMH-E	SW1 ON OFF 1 2 3 4 5 6 7 8 9 10	SW2 ON OFF 1 2 3 4 5 6	SW3 ON OFF 1 2 3 4 5 6 7 8 9 10	SW4 ON OFF 1 2 3 4 5	SW5 ON OFF 220V 240V		
PEFY-P250VMH-E	SW1 ON OFF 1 2 3 4 5 6 7 8 9 10	SW2 ON OFF 1 2 3 4 5 6	SW3 ON OFF 1 2 3 4 5 6 7 8 9 10	SW4 ON OFF 1 2 3 4 5	SW5 ON OFF 220V 240V		

7-4. Attention for test run

Equipment which is attached drain water lift up kit can be tested pump out test when power supplied.(connect the connector(A))

< Drain-up machine >

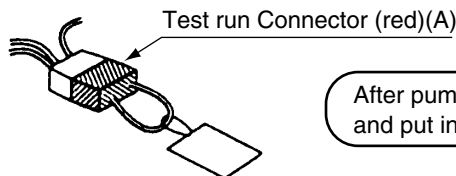

After pump out test, remove the connector and put in the dummy connector.

After test run,remove the connector (A)(Fig .1)

7-5. Function the LED of the indoor unit service board

Symbol	Silk display	LED operation under normal state
LED1	Main power source	At applying main power source (indoor unit 200V) → Lighting
LED2	Transmission power source	At receiving M-NET transmission power source → Lighting

8-1. CONTROL BOX

Be careful on removing heavy parts.

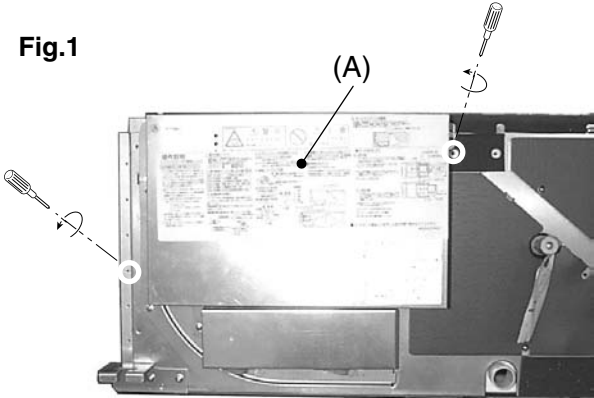
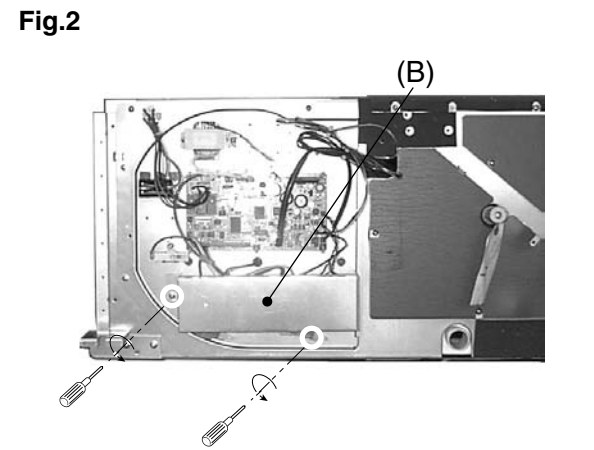
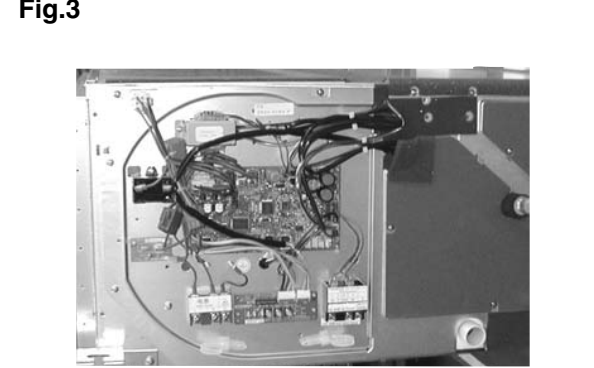
OPERATING PROCEDURE	PHOTOS
<p>Models 40~140</p> <p>1.Removing the control box cover</p> <p>(1) Remove the fixing screws (two) of the control box (A), and remove the cover. (Fig. 1)</p> <p>*At this stage, the following servicing is possible.</p> <p>1 Operation and check of the switches (listed below) which are on the control board.</p> <ul style="list-style-type: none"> • Dip switch SW2 Capacity code setting • Dip switch SW3 Function change • Dip switch SW4 Model code setting <p>2 Connection check of the lead wires (listed below) which are connected to the controller board.</p> <ul style="list-style-type: none"> • Power supply lead wire. • Network remote controller transmission lead wire. • Fan motor lead wire. • LEV lead wire • Intake air sensor lead wire • Liquid piping sensor lead wire • Gas piping sensor lead wire • Power supply transformer lead wire Address board lead wire <ul style="list-style-type: none"> (• Drain pump lead wire) (• Drain sensor lead wire) <p>3 Control board exchange</p> <p>4 Condenser exchange</p> <p>5 Power supply transformer exchange</p> <p>6 Arrest exchange</p> <p>7 Intake air sensor exchange</p> <p>():Optional parts</p> <p>2.Removing the terminal bed cover</p> <p>(1) Remove the fixing screws (two) of the terminal bed cover (B), and remove the cover. (Fig. 2)</p> <p>*At this stage, the following servicing is possible.(Fig. 3)</p> <p>1 Operation and check of the switches (listed below) which are on the adress board.</p> <ul style="list-style-type: none"> • Rotary switches SW11, 12 ... Address setting • Rotary switch SW14 Branch port setting • Dip switch SW1 Function change (main) <p>2 Address board exchange</p> <p>3 Power supply terminal bed exchange</p> <p>4 Transmission terminal bed exchange</p>	<p>Fig.1</p>  <p>Fig.2</p>  <p>Fig.3</p> 

Be careful on removing heavy parts.

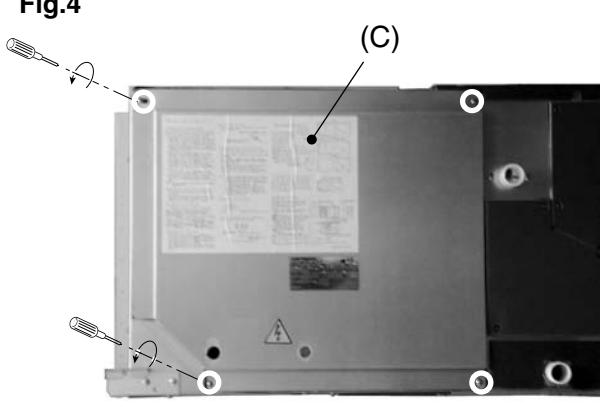
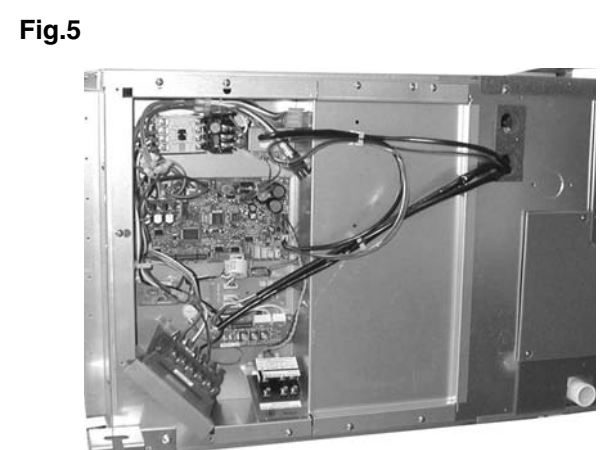
OPERATING PROCEDURE	PHOTOS
<p>Models 200-250</p> <p>1.Removing the control box cover</p> <p>(1) Remove the fixing screws (four) of the control box cover (C), and remove the cover. (Fig. 4)</p> <p>*At this stage, the following servicing is possible.(Fig. 5)</p> <ol style="list-style-type: none">1 Operation and check of the switches (listed below) which are on the control board.<ul style="list-style-type: none">• Dip switch SW2 Capacity code setting• Dip switch SW3 Function change• Dip switch SW4 Model code setting2 Connection check of the lead wires (listed below) which are connected to the controller board.<ul style="list-style-type: none">• Power supply lead wire.• Network remote controller transmission lead wire.• Fan motor lead wire.• LEV lead wire• Intake air sensor lead wire• Liquid piping sensor lead wire• Gas piping sensor lead wire• Power supply transformer lead wire• Address board lead wire<ul style="list-style-type: none">(• Drain pump lead wire)(• Drain sensor lead wire)3 Control board exchange4 Power supply transformer exchange5 Arrest exchange6 Intake air sensor exchange7 Operation and check of the switches (listed below) which are on the address board<ul style="list-style-type: none">• Rotary switches SW11, 12 Address setting• Rotary switch SW14 Branch port setting• Dip switch SW1..... Function change (main)8 Address board exchange9 Power supply terminal bed exchange10 Transmission terminal bed exchange <p>():Optional parts</p>	<p>Fig.4</p>  <p>Fig.5</p> 

Be careful on removing heavy parts.

8-2. FAN and FAN MOTOR

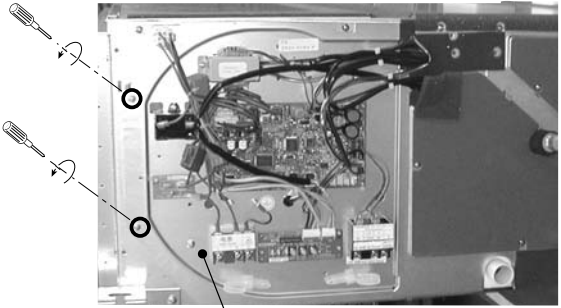
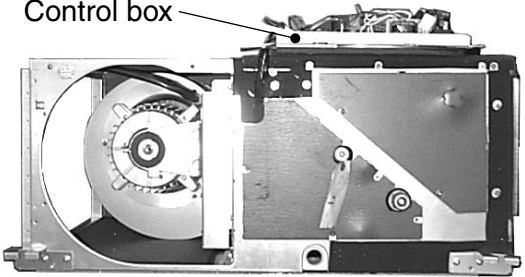
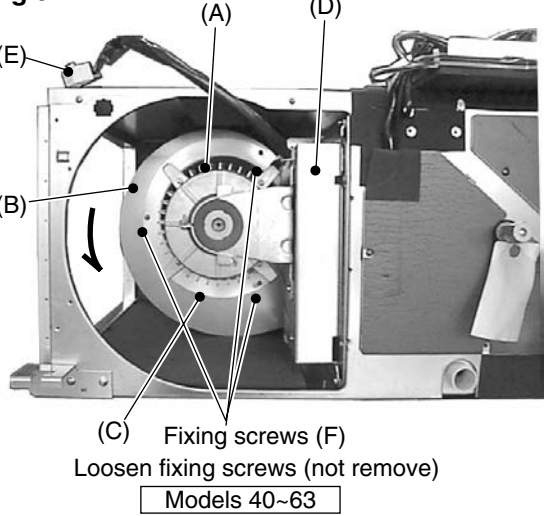
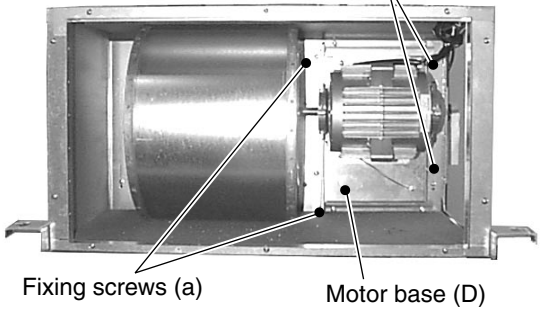
OPERATING PROCEDURE	PHOTOS
<p>Models 40~140</p> <p>1.Removing the control box.</p> <ol style="list-style-type: none">(1) Remove the control box cover and terminal bed cover with procedure 8-1.(2) Remove the fan motor connectors.(3) Remove the fixing screws (two) of the control box and slide the control box to remove.(Fig. 1)(4) Move the control box to place that is not block operation. (Fig. 2)	<p>Fig.1</p>  <p>Fig.2</p> <p>Control box</p> 
<p>2.Removing the fan motor</p> <p>Models 40~80</p> <p>*After motor base (D) and bell mouse (C) attached the fan case (B) removed,motor (A) can be pull with motor base and fan along rail.</p> <ol style="list-style-type: none">(1) Remove the fan motor connector (E).(2) Loosen the fixing screws (F) (three) of the bell mouse (C), and removed the bell mouse (D) turning screws in direction arrow (counterclockwise).(Fig. 3)(3) Remove the fixing screws (four) of the motor base(D). <p>Notice: It's necessary using the driver over 30cm length to remove the fixing screws (a) . (Fixing screws are placed back)</p>	<p>Fig.3</p>  <p>Fig.4</p> <p>Fixing screws</p> 

Be careful on removing heavy parts.

OPERATING PROCEDURE

- (4) Slide the motor (A) with motor base (D) in direction of allow
①. (Fig. 5)

PHOTOS

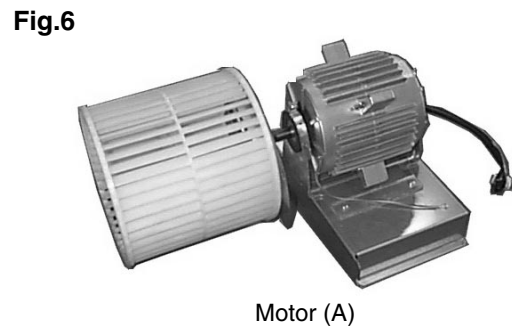
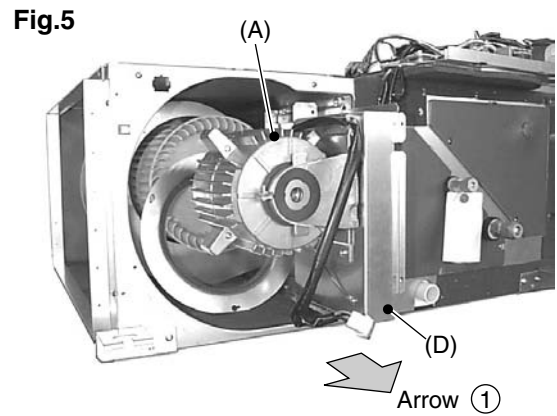

Models 100~140

*Motor maintenance procedure is almost 40~80 models procedure.
Models 100~140 have twin shaft motor. After removing the fan and fan case which are in front of motor, remove the motor.

- (1) Remove the bell mouse of the front fan motor with procedure models 40~140.
- (2) Loosen the setting screws of the front fan, removed the fan.
- (3) Remove the front fan case.
- (4) Operate with procedure models 40~80.

Notice: Fixing screws of the fan case are shown Fig. 7.
Remove the fixing screws (H), fan case can be removed.

Fig.7

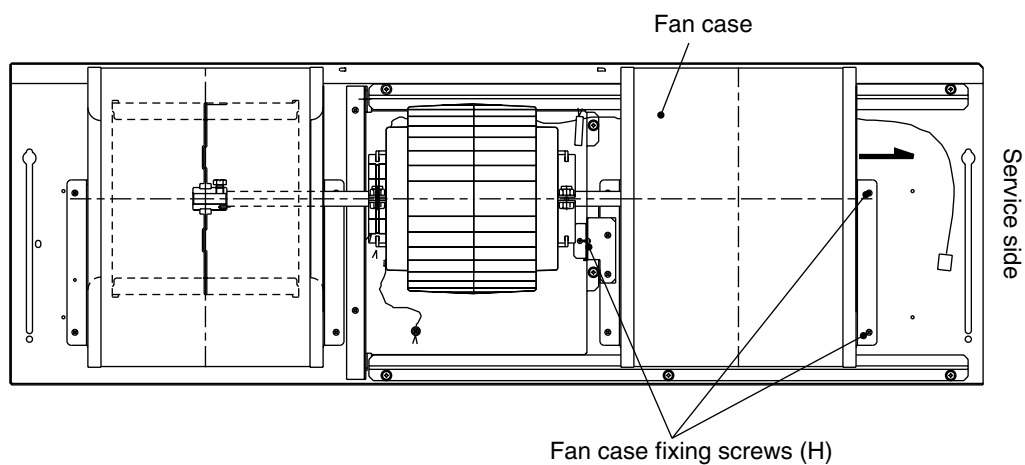

Be careful on removing heavy parts.

OPERATING PROCEDURE

Models 200-250

1.Removing the control box.

- (1) Remove the control box cover1 with procedure 8-1.
- (2) Remove the fixing screws (four) of the control cover 2, and remove the control cover2. (Fig. 7)
- (3) Remove the fan motor connectors.
- (4) Remove the fixing screws (three) of the control box and remove the control box (Fig. 8)
- (5) Move the control box to place that is not block operation. (Fig. 9)

2.Removing the fan motor

*After the fan (A) ,the fan case (B) and the bell mouse (C) removed, motor can be pull with motor base and inner fan along rail.

- (1) Remove the fixing screws (three) of the bell mouse (C), and remove the bell mouse (C). (Fig. 3)
- (2) Loosen the setting screws (G) of the front fan , removed the fan.(Fig. 10)

PHOTOS

Fig.7

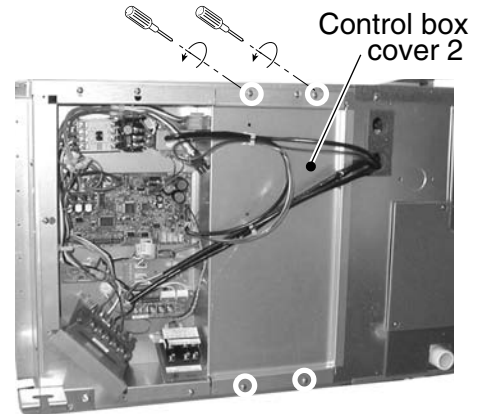

Fig.8

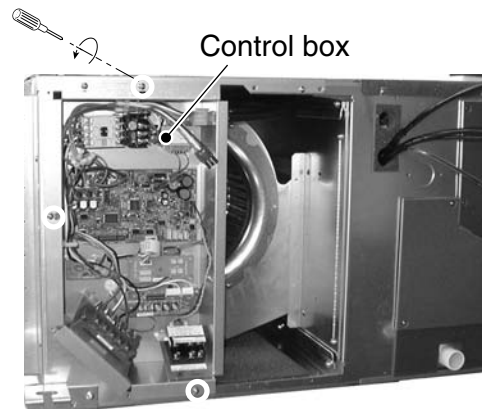

Fig.9

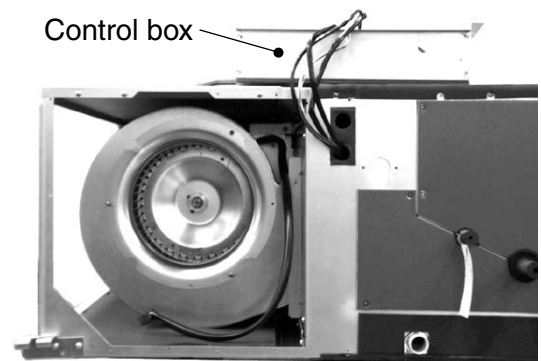
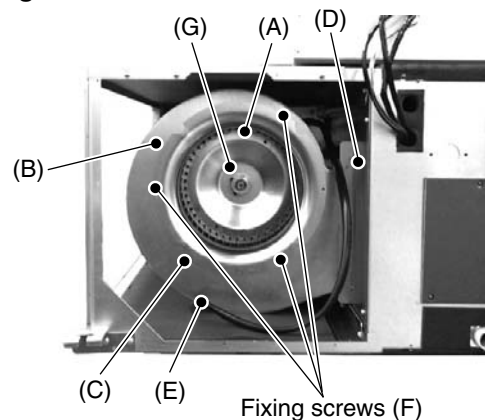

Fig.10



Be careful on removing heavy parts.

OPERATING PROCEDURE

(3) After removing the fixing screws (H)(as shown models 100~140) of the front fan case(B) and remove the fan. Pull the fan case (B).

(4) Remove the fixing screws (K)(three) of the bell mouse (J) attached fan case (L), and remove the bell mouse (J). (Fig.12)

(5) Remove the fixing screws (four) of the motor base(D).

Notice: It's necessary using the driver over 30cm length to remove the fixing screws (a) . (Fixing screws are placed back)(Fig. 13)

(6) Slide the motor (M) with motor base (D) in direction of arrow ②. (Fig. 14)

Notice: It's not necessary removing the fan case (L).

PHOTOS

Fig.11

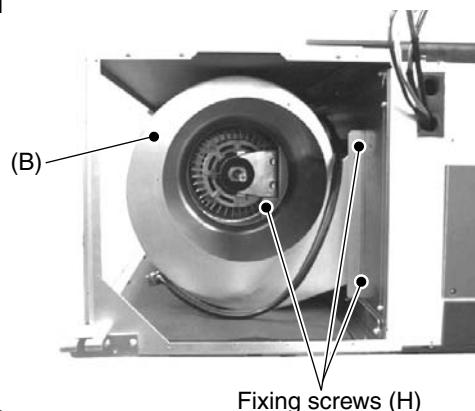

Fig.12

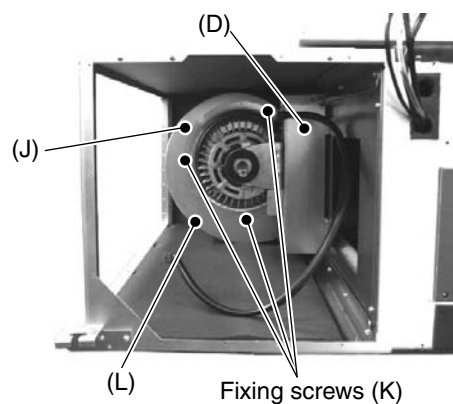

Fig.13

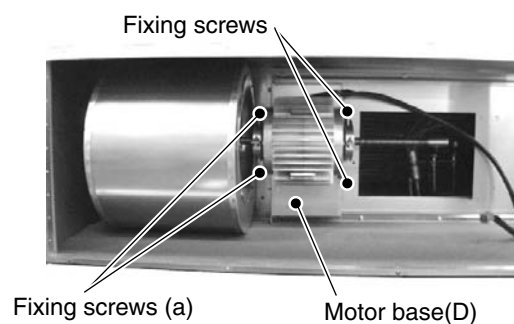

Fig.14

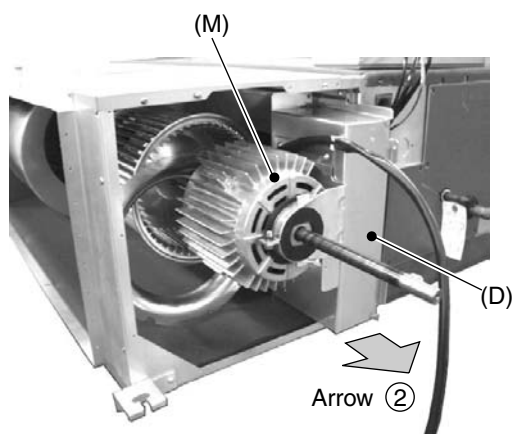
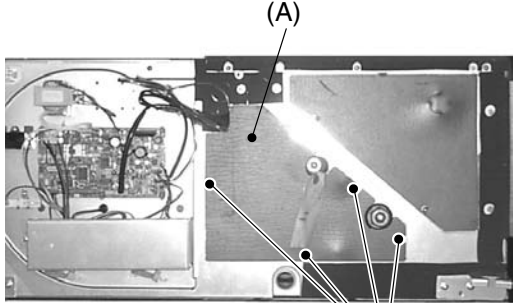
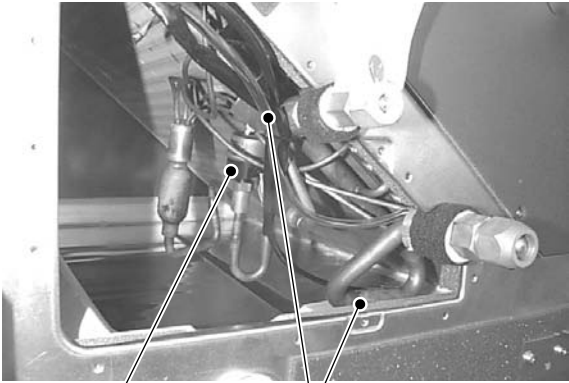
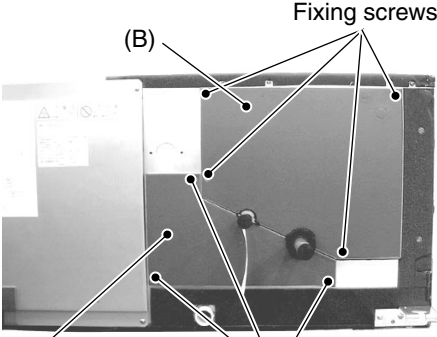
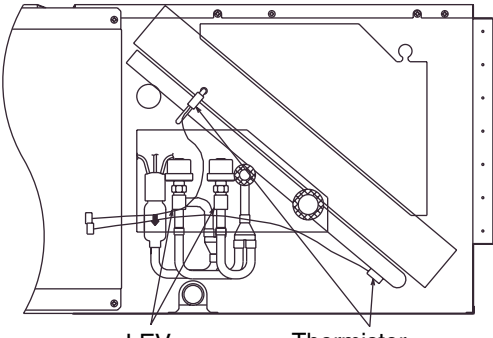

Fig.15



8-3. LEV, THERMISTOR (Liquid/Gas piping temperature detection)

Be careful on removing heavy parts.

OPERATING PROCEDURE	PHOTOS
<p>Models 40~140</p> <p>1.Removing the LEV.</p> <p>(1) Remove the control box cover with procedure 8-1.</p> <p>(2) Remove the fixing screws (four) of the heat exchanger cover (A), and remove the cover (A).(Fig. 1)</p> <p>(3) Remove the LEV driving motor with a double spanner.(Fig. 2)</p> <p>2.Removing the thermistors.</p> <p>(1) Remove the thermistors from the thermistor holders which are installed on the piping.(Fig. 2)</p> <p>(liquid piping : fine piping , gas piping : thick piping)</p>	<p>Fig.1</p>  <p>(A)</p> <p>Fixing screws</p> <p>Fig.2</p>  <p>LEV</p> <p>Thermistor</p>
<p>Models 200-250</p> <p>1.Removing the LEV. (These models have 2 LEV)</p> <p>(1) Remove the fixing screws (three) of the heat exchanger cover (A), and remove the cover (A).</p> <p>(2) Remove the fixing screws (four) of the maintenance cover (B), and remove the cover (B).(Fig. 3)</p> <p>(3) Remove the LEV driving motor with a double spanner.(Fig. 4)</p> <p>2.Removing the thermistors.</p> <p>(1) Remove the thermistors from the thermistor holders which are installed on the piping.(Fig. 4)</p> <p>(liquid piping : fine piping , gas piping : thick piping)</p>	<p>Fig.3</p>  <p>(B)</p> <p>Fixing screws</p> <p>(A)</p> <p>Fixing screws</p> <p>Fig.4</p>  <p>LEV</p> <p>Thermistor</p>

8-4. HEAT EXCHANGER

Be careful on removing heavy parts.

OPERATING PROCEDURE

Models 40~140

1.Removing the heat exchanger.

- (1) Remove the heat exchanger cover with procedure 8-3-1.
- (2) Remove the bottom plate which is air outlet side.(fixing screws : ten) (Fig. 1)
- (3) Remove the drainpan.(Fig. 2)

PHOTOS

Fig.1

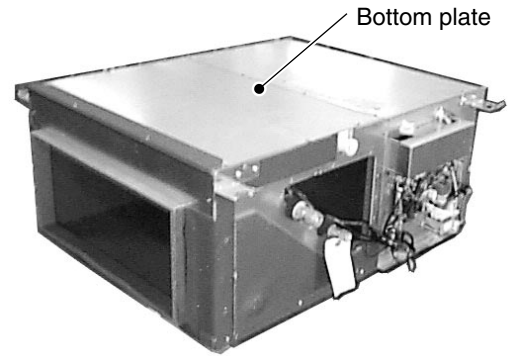

Fig.2

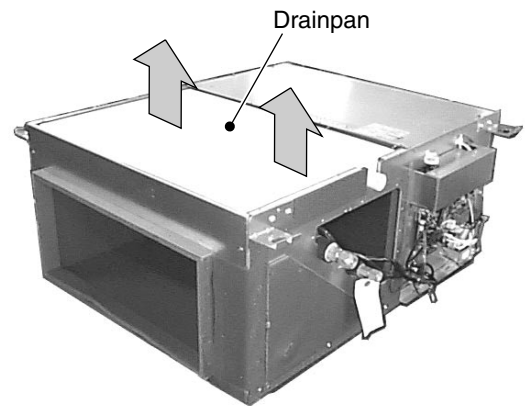
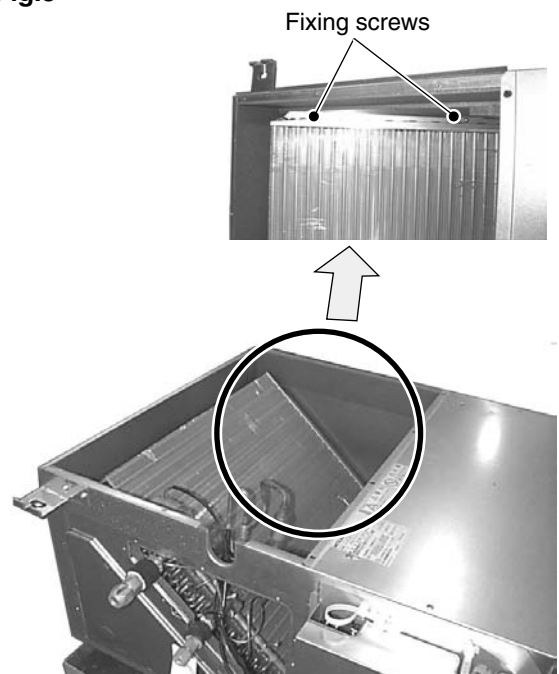

Fig.3



Be careful on removing heavy parts.

OPERATING PROCEDURE

- (4) Remove the maintenance cover.(fixing screws : two) (Fig. 4)
- (5) Remove the heat exchanger.(fixing screws : four) (Fig. 3,5)

*Removed heat exchanger is as shown Fig.6

PHOTOS

Fig.4

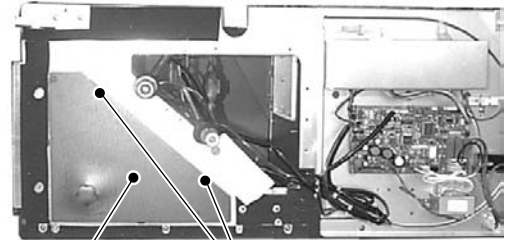

Maintenance cover Fixing screws

Fig.5

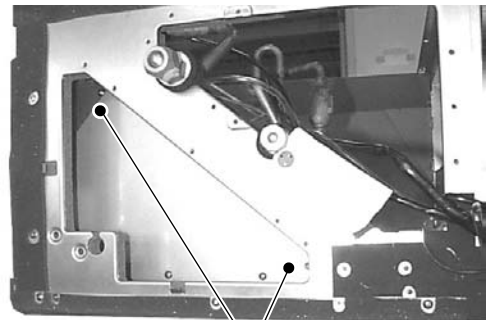

Fixing screws

Fig.6

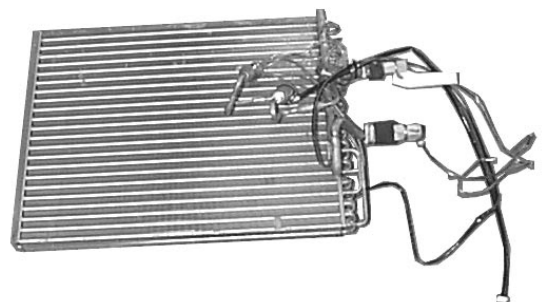

Be careful on removing heavy parts.

OPERATING PROCEDURE

Models 200-250

1.Removing the heat exchanger.

- (1) Remove the refrigerant piping and drain hose from main unit.(Be care that water is not leaking from drain hose.)
- (2) Remove the power supply wire and the transmission line. (Make sure that power source is turning off.)
- (3) Pull down the main unit.
- (4) Turn over the main unit upside the bottom plate
- (5) Remove the bottom plate which is air outlet side.(fixing screws : fifteen) (Fig. 7)
- (6) Remove the drainpan.(Fig. 8)

PHOTOS

Fig.7

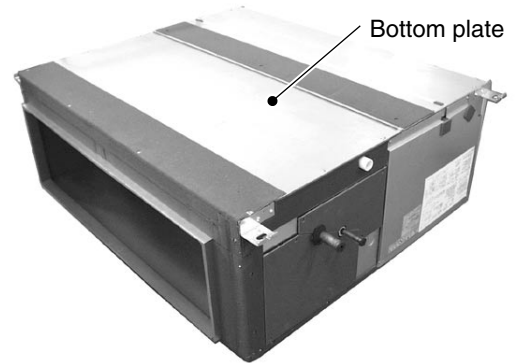

Fig.8

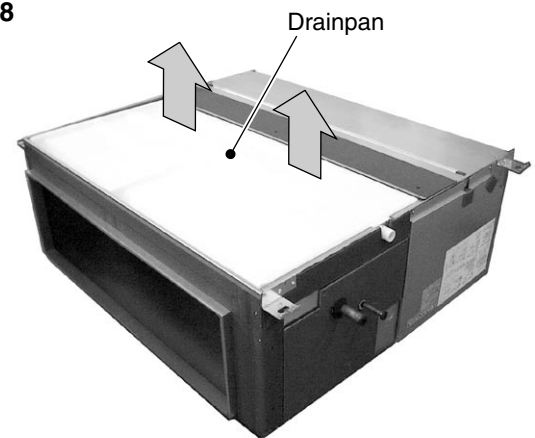
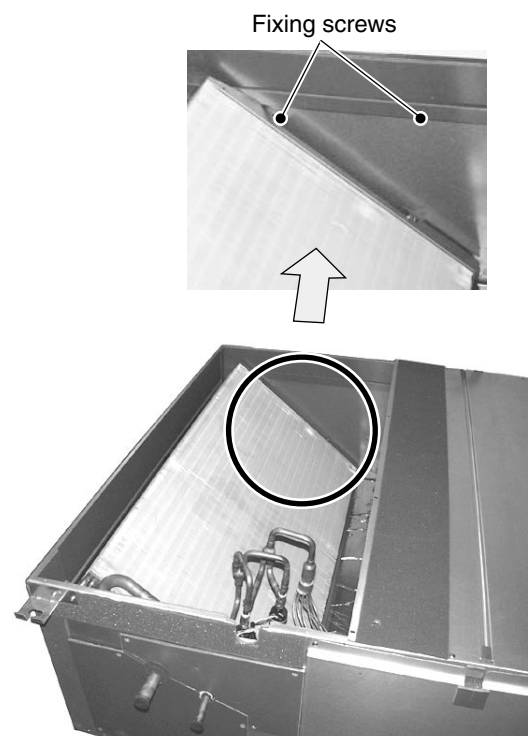

Fig.9



Be careful on removing heavy parts.

OPERATING PROCEDURE

- (7) Remove the fixing screws (three) of the heat exchanger cover, and remove the cover. Remove the fixing screws (four) of the maintenance cover, and remove the cover. (Fig. 10)
- (7) Remove the heat exchanger.
Fixing screws(non-piping side) : two (Fig. 9)
Fixing screws(piping side) : two (Fig. 11)

*Removed heat exchanger is as shown Fig.12

PHOTOS

Fig.10

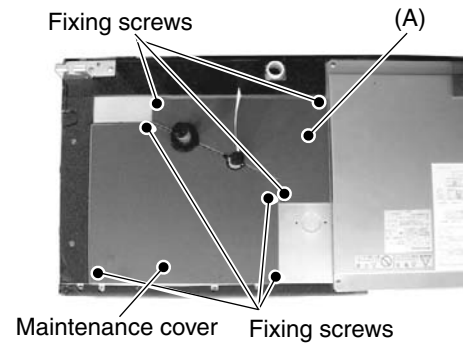

Fig.11

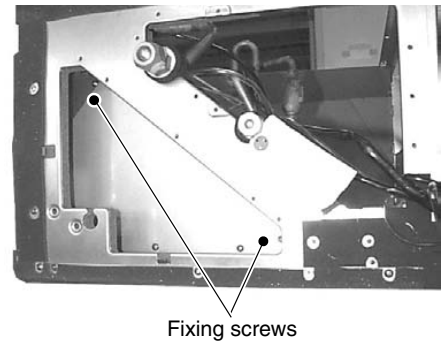
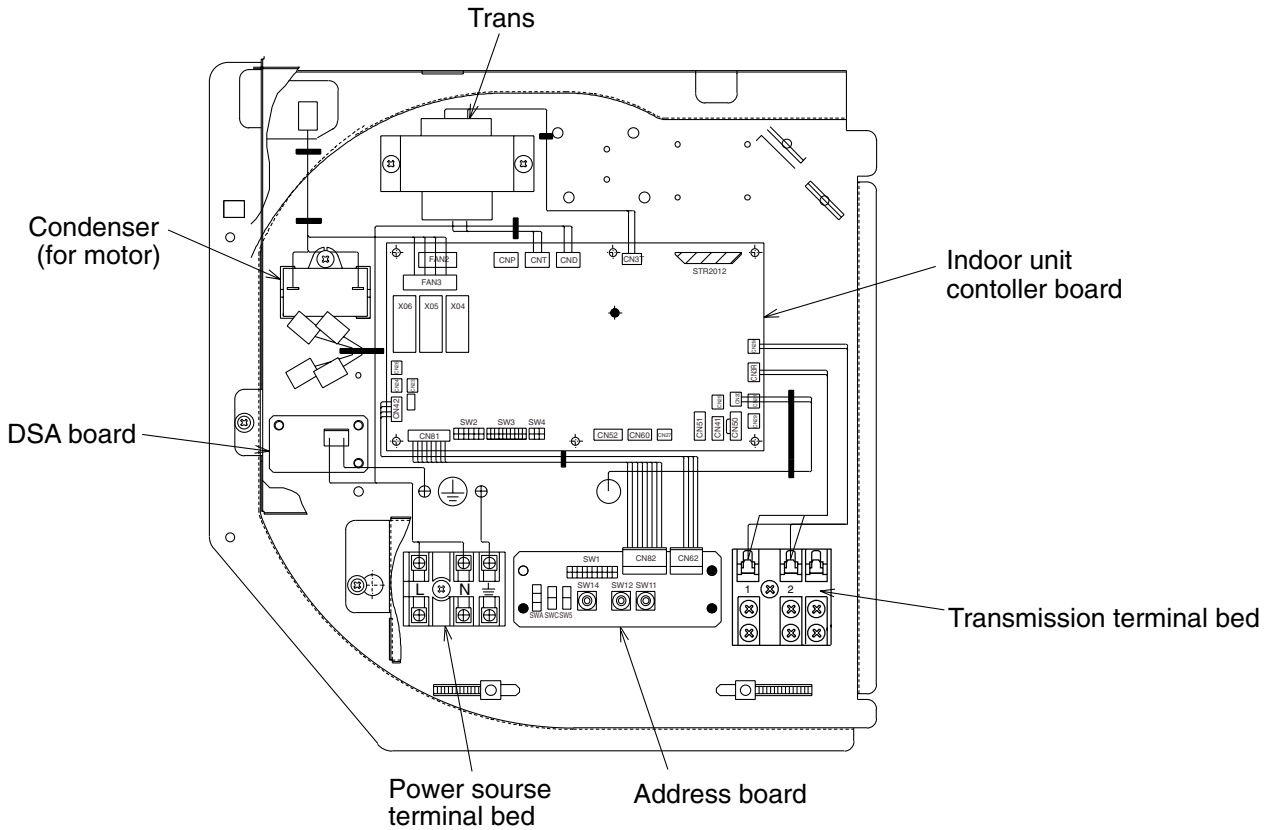

Fig.12



8-5. CONTROL BOX INSIDE LAYOUT

Models 40~140



Models 200-250

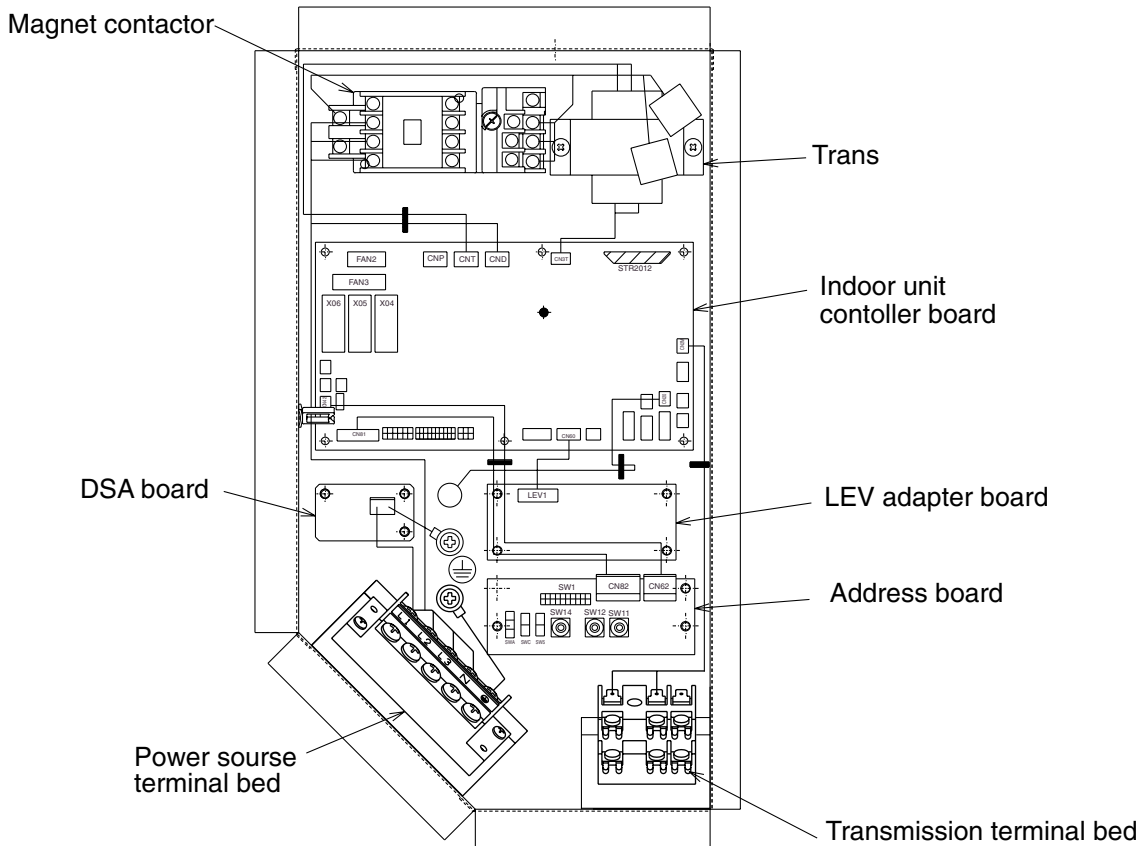



8-6. SENSOR POSITION

●PEFY-P40VMH-E

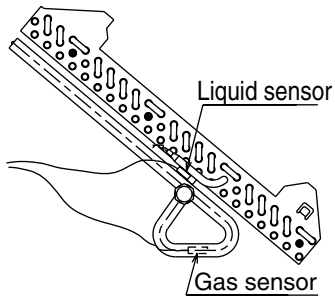

●PEFY-P50-63VMH-E

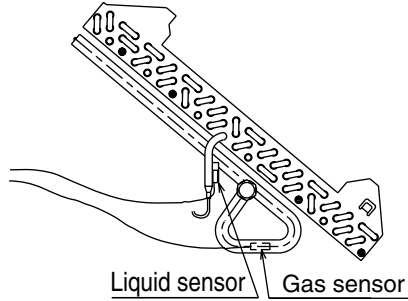

●PEFY-P71-80VMH-E

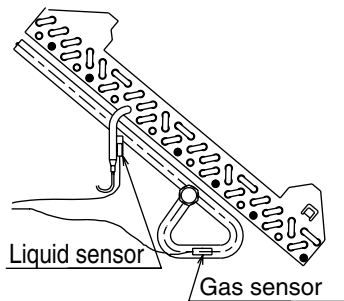

●PEFY-P100-125VMH-E

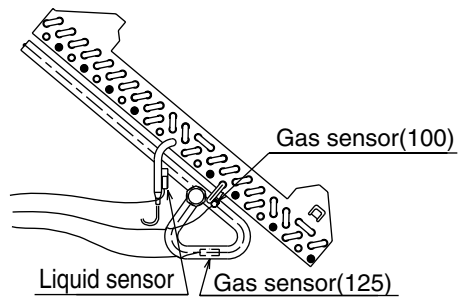

●PEFY-P140VMH-E

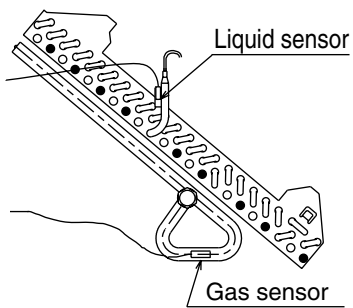

●PEFY-P200-250VMH-E

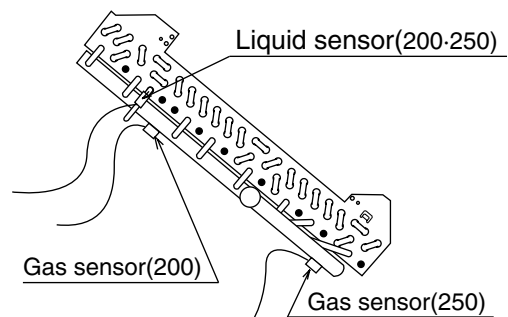



HEAD OFFICE: MITSUBISHI DENKI BLDG., 2-2-3, MARUNOUCHI, CHIYODA-KU, TOKYO 100-8310, JAPAN
